

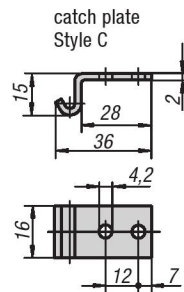

# Adjustable Latches

screw-on holes visible

METRIC Parts

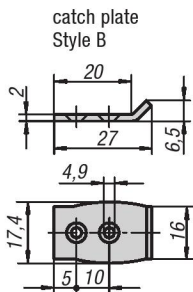
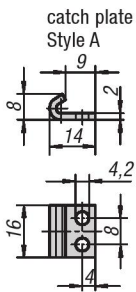
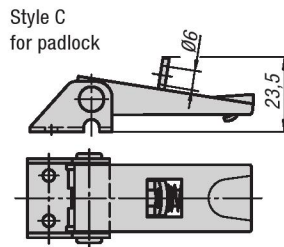
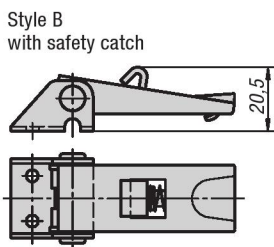
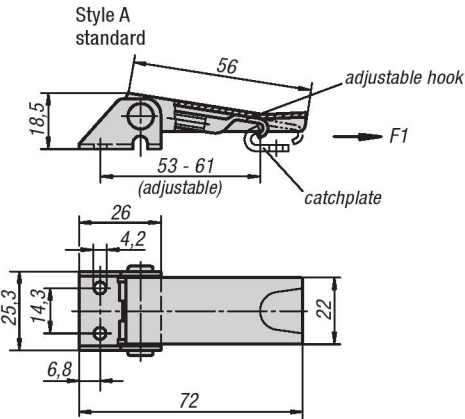

hole arrangements for mounting with catch plate

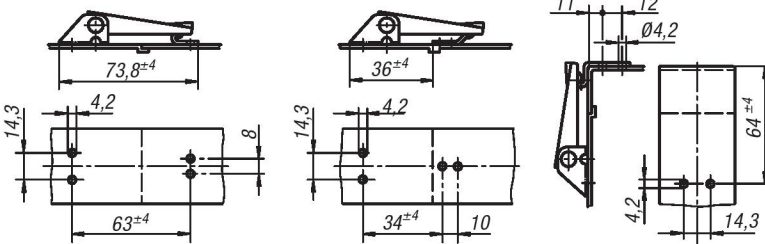

**Material:**  
Steel or stainless steel 1.4301

**Type:**  
Galvanized and blue chromate.  
stainless steel natural finish.

**Part Number Example:**  
Latch K0046.1420721  
Catch plate K0046.9142141

**Note:**  
Adjustable latches are safe locking systems for industrial applications. By exceeding the dead center they resist vibration.

After the hook is engaged with the catch plate, by pushing the lever down the parts to be locked can be drawn together by up to 5 mm.

To compensate for tolerances or to create enough tension, the hook length can be adjusted using the M5 threaded spindle.

The latches can be screwed down riveted.

Any catch plate can be combined with any latch.

Order required catch plate version separately.

The retaining force F1 applies to the latch, not the catch plate.

## KIPP Adjustable Latches screw-on holes visible, metric

Item No. steel	Item No. stainless steel	Style	Retaining force F1 N
K0046.1420721	K0046.1420722	A	1000
K0046.2420721	K0046.2420722	B	1000
K0046.3420721	K0046.3420722	C	1000

## KIPP Catch plate, metric

Item No. steel	Item No. stainless steel	Style
K0046.9142141	K0046.9142142	A
K0046.9242271	K0046.9242272	B
K0046.9342381	K0046.9342382	C