

DE-STA-CO WORKHOLDING MATERIAL AND PART HANDLING SOLUTIONS

BodyBuilder

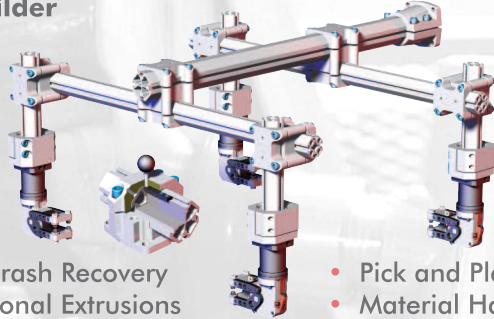

- Fast Crash Recovery
- Octagonal Extrusions
- Modular Components
- Pick and Place
- Material Handling
- Robot Welding

SpiderGrip

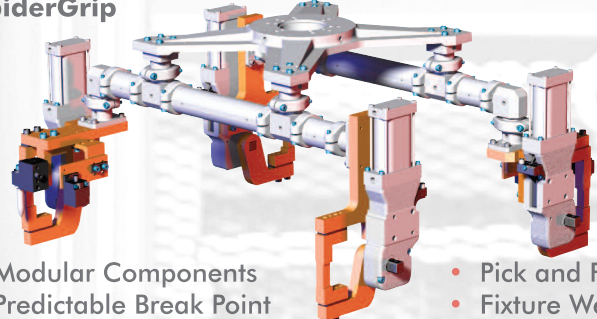

- Modular Components
- Predictable Break Point
- Maintains Accuracy
- Pick and Place
- Fixture Welding
- Geo End Effector

CPI Round Tooling

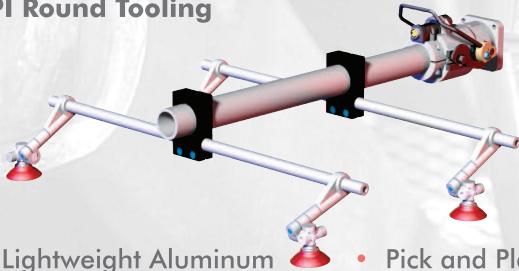

- Lightweight Aluminum
- Modular Components
- Easy Reconfiguration
- Pick and Place
- Material Handling
- Pressroom

Carbon Fiber Booms and Tubing

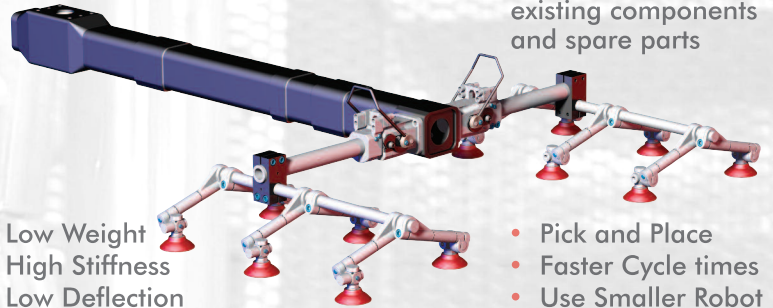

Compatible with existing components and spare parts

- Low Weight
- High Stiffness
- Low Deflection
- Pick and Place
- Faster Cycle times
- Use Smaller Robot

Manual Tool Changers

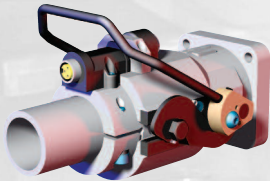

Single Hand Operation

Automatic Tool Changers

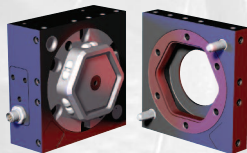

Heavy Duty Spring Loaded Locking Mechanism

Load Limiters

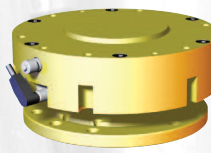

Provides Protection to Robot/Tooling

Lateral Compliance Devices

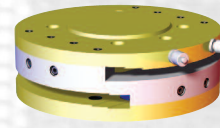

Compensates for Misalignments

Compliance Wrist

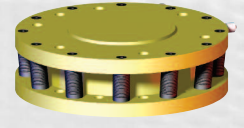

Increased Assembly Speeds

Auto Release Venturi (ARV)

- Instant Part Release
- Quiet Operation
- Simplified Plumbing
- Requires only (1) air supply line and (1) valve for greater air savings



Vacuum Cups Mounts



Cup mount for remote vacuum source

Vacuum Cups



Offered in various styles, sizes and durometers for different applications

Spring Cup Mounts (Level Compensator)

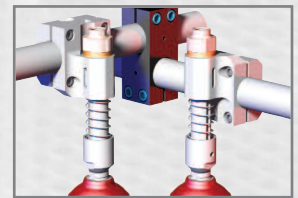

Magnets



Instant part pick-up/release w/o electricity

Sheet Metal Grippers



Toggle-Lock Mechanism holds part if air pressure is lost

Pin Clamps

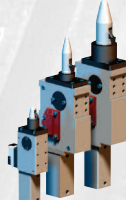

Power Clamps



Pivot Units

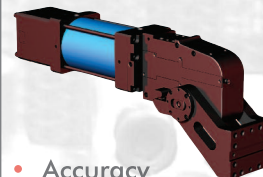

- Accuracy
- Motion Control
- Flexible Mounting

Weld Slides

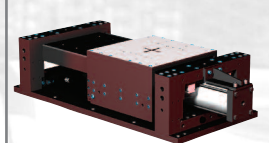

- Inverted Design
- Sealed Bearings
- Hi-Capacity loads

DE-STA-CO offers engineering services to help design a complete customized solution to fit your needs



A DOVER COMPANY

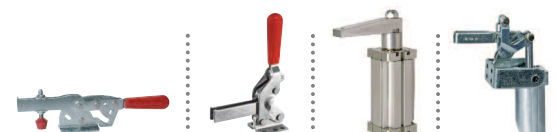

DE-STA-CO WORKHOLDING MATERIAL AND PART HANDLING SOLUTIONS

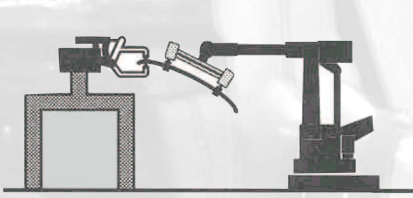

Robotic and Fixture Welding

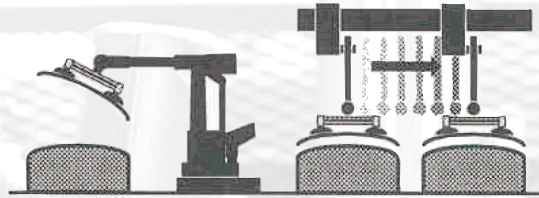

Press to Press Transfer, Pick and Place

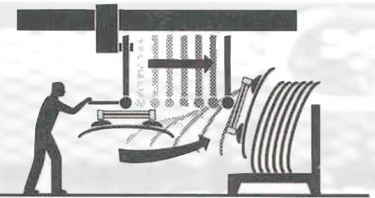

Manual Assist and Manipulation

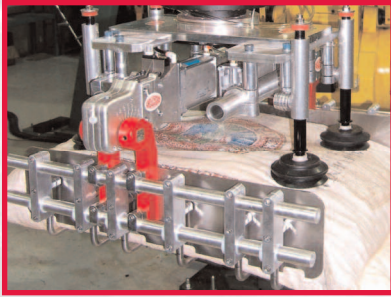

Bag Lifting and Palletizing Tool

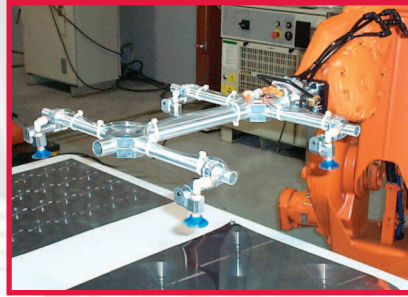

Sheet Metal lifting with Round Tooling

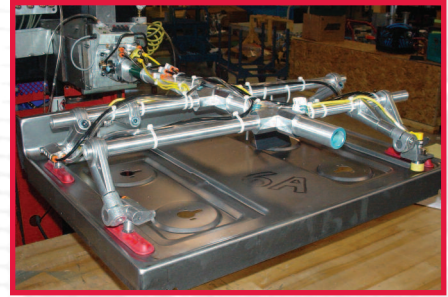

Stove Top Transfer with Round Tooling

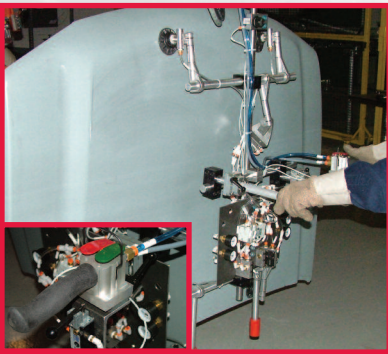

Manual Assesst with Round Tooling

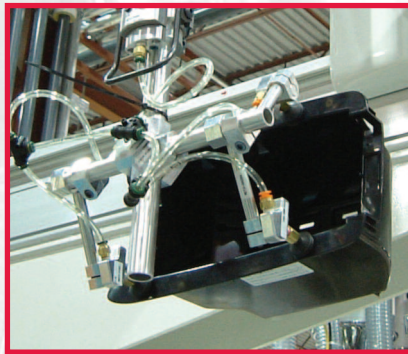

Plastics Handling with Round Tooling

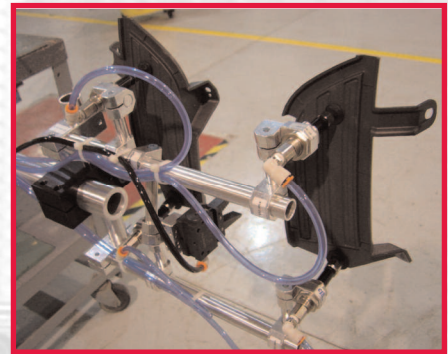

Plastics Injection Mold Unload Tool

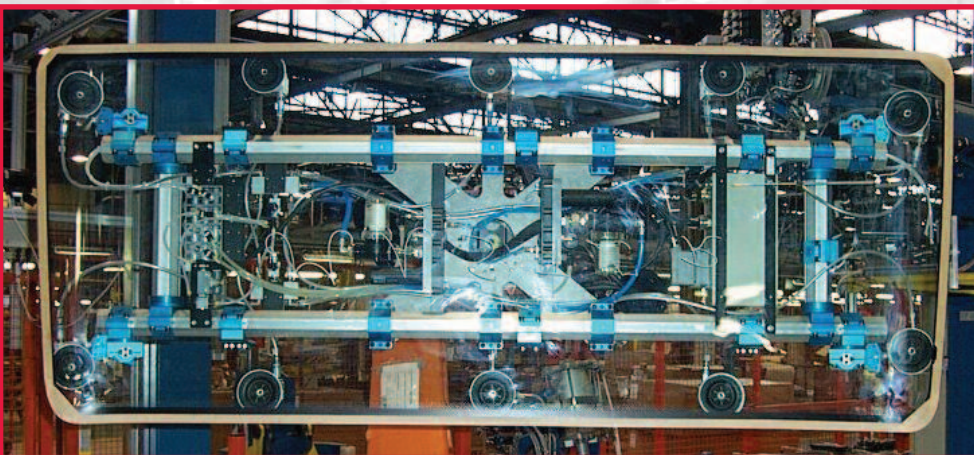

Glass Handling with BodyBuilder™ and Vacuum Cups

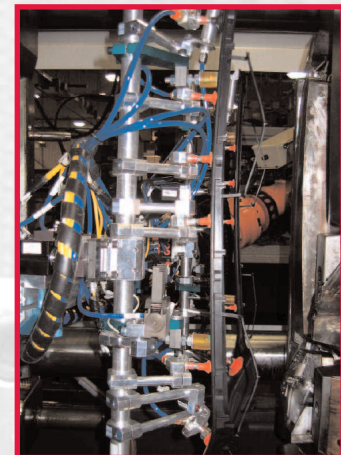

Plastic Seat Trim Tool



A DOVER COMPANY

